

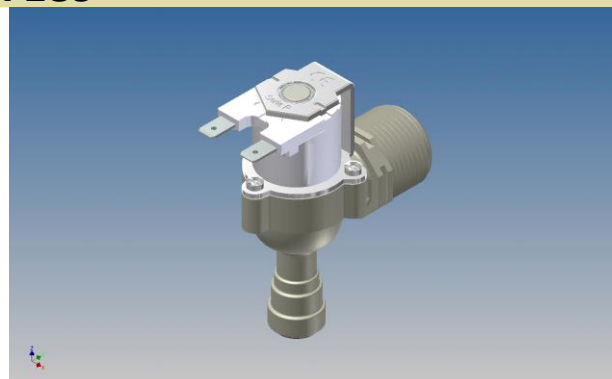

Rpe s.r.l.
Via S. Ambrogio, 3
22070 Carbonate (CO)
Italy
Tel. +39 0331832515
Fax +39 0331832501
www.rpesrl.it

Elettrovalvola Serie R

R 189



CLASSIFICAZIONE



Tipologia	Semplice
Geometria	90°

CARATTERISTICHE DI LAVORO

Pressione di esercizio	0,2 ÷ 10 bar
Temperatura ambiente	0 ÷ 60°C
Temperatura fluido	25°C; 60°C; 90°C
Ciclo di lavoro	ED 100%; ED 60%(90°C)
Direzione del fluido	Unidirezionale
Diametro di passaggio	DN 8 mm
Comando	Bistabile; NA; NC

CARATTERISTICHE FISICHE

Corpo valvola	PA 6,6 30% fibra vetro
Membrane e guarnizioni	EPDM; NBR (buna); Silicone (MVQ)
Nucleo	Acciaio INOX
Molla	Acciaio INOX
Assemblaggio	Con viti ispezionabile

CONNESSIONI IDRAULICHE

Connessioni in ingresso	Filetto BSP (GAS) 3/4" M
Connessioni in uscita	Attacco rapido JG 8 mm

CONNESSIONI ELETTRICHE

Connessioni elettriche 1	Faston Maschio 6,3 x 0,8 mm
Connessioni elettriche 2	Cavi unipolari max 5 m
Connessioni elettriche 3	Cavi bipolari max 5 m

APPLICAZIONI

La serie R elettrodomestico è utilizzata ovunque sia necessario il controllo automatico dell'acqua. Carico H2O lavatrice, Lavastoviglie, Frigoriferi, Macchine ghiaccio, Distributori acqua, Forni industriali, Rubinetteria, Idromassaggio, Macchine caffè.

CLASSIFICATION



Type	Single
Geometria	90°

WORKING SPECIFICATIONS

Working pressure	0,2 ÷ 10 bar
Room temperature	0 ÷ 60°C
Fluid temperature	25°C; 60°C; 90°C
Duty cycle	ED 100%; ED 60%(90°C)
Flow direction	Unidirectional
Nominal diameter	DN 8 mm
Control	Latching; NC; NO

PHYSICAL SPECIFICATIONS

Valve body	PA 6,6 30% fiber glass
Diaphragms gasket	EPDM; NBR (buna); Silicone (MVQ)
Core	Stainless Steel
Spring	Stainless Steel
Assembly	With screws for inspection

HYDRAULIC CONNECTIONS

Inlet	3/4" BSP Male thread
Outlet	Quick connection JG 8 mm

ELECTRICAL CONNECTIONS

Electric connect 1	Male Faston 6,3 x 0,8 mm
Electric connect 2	Unipolar cables max 5 m
Electric connect 3	Bipolar cables max 5 m

APPLICATIONS

The series R for household apps can be used wherever automatic water control is needed. Washing machines and dish washes water filling, Refrigerators, Ice machines, Water dispensers, Industrial ovens, Taps, Hydromassage, Coffee makers.

MARCHI E APPROVAZIONI / CERTIFICATION MARKS



Revisione Rev 0

20/05/11

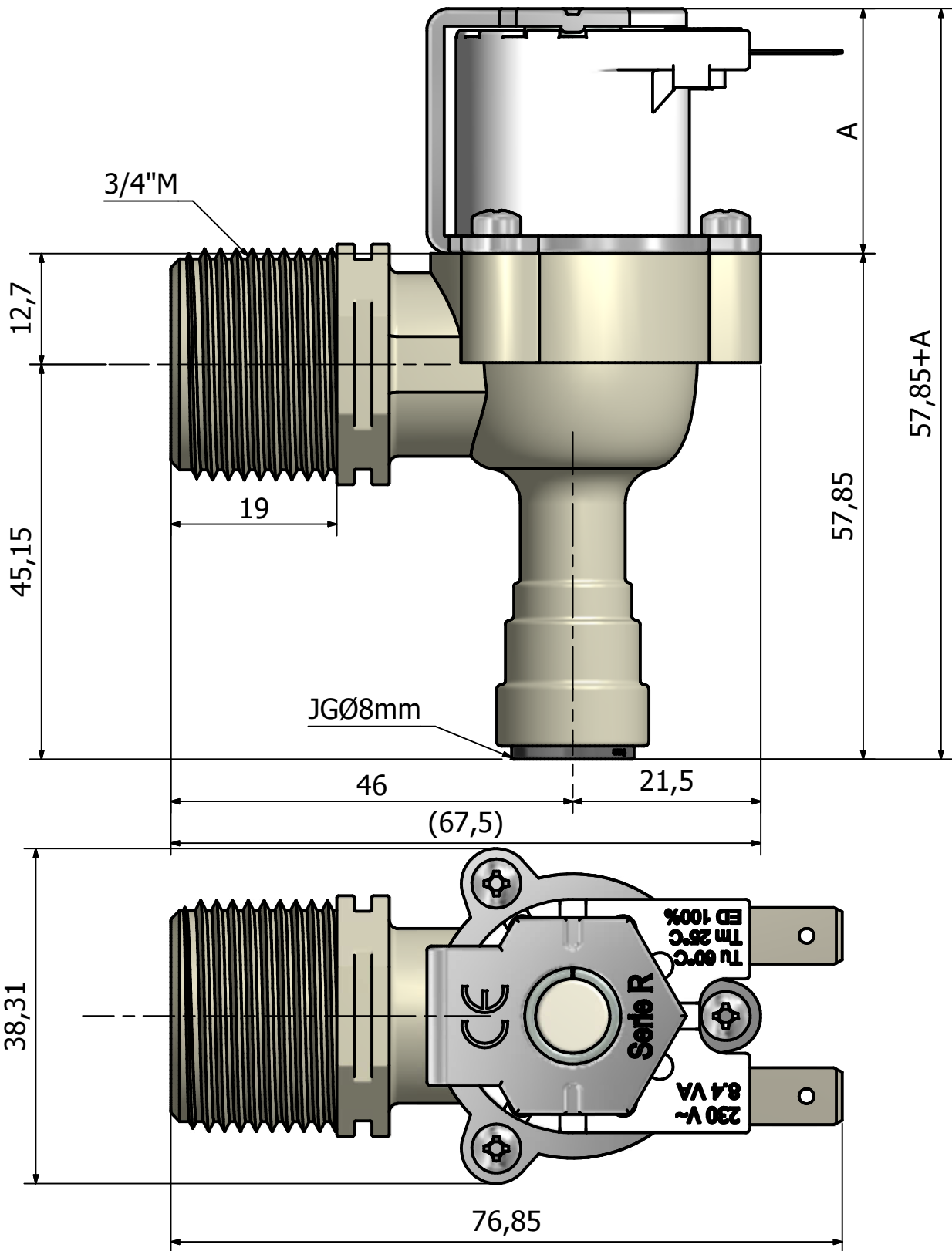

Dimension A (mm)

Normalmente chiusa con faston <i>Normally closed with faston</i>	28
Normalmente chiusa con cavi <i>Normally closed with cable</i>	29,2
Normalmente aperta <i>Normally open</i>	47,2
Bistabile <i>Latching</i>	38,3



R 189

Serie:

R



Data: 10/03/2011

Revisione:

0